

Overview of IFMIF-DONES diagnostics: Requirements and techniques

C. Torregrosa-Martin ^{a,*}, A. Ibarra ^{b,c}, J. Aguilar ^a, F. Ambi ^s, F. Arranz ^c, F. Arbeiter ^d, A. Bagnasco ^s, S. Becerril ^a, D. Bernardi ^e, B. Bolzon ^f, E. Botta ^s, B. Brenneis ^d, M. Cappelli ^g, P. Cara ^h, J. Castellanos ⁱ, D. Cosic ^j, C. De la Morena ^c, A. Diez ^c, G. Ericsson ^k, A. García ^c, M. García ^c, B. Garcinuño ^c, J. Gutiérrez ^o, V. Gutiérrez ^c, D. Jimenez-Rey ^c, T. Dezsí ^l, M. Juni Ferreira ^m, S. Fiore ^g, W. Krolas ⁿ, R. Lorenzo ^a, M. Luque ^a, L. Maciá ^r, J. Marroncle ^f, F. Martin-Fuertes ^c, J.C. Marugán ^o, J. Maestre ^a, C. Meléndez ^p, G. Micciché ^e, J. Mollá ^c, A. Moreno ^a, F.S. Nitti ^e, C. Núñez ^p, F. Ogando ^q, T. Pinna ^e, C. Oliver ^c, I. Podadera ^{b,c}, C. Prieto ^o, R. Prokopowicz ^t, Y. Qiu ^d, D. Rapisarda ^c, D. Regidor ^c, E. Rodríguez ^p, A. Sabogal ^a, D. Sánchez-Herranz ^a, M. Sanmarti ^r, L. Seguí ^f, A. Serikov ^d, T. Tadić ^j, A. Talarowska ^t, U. Wiacek ⁿ, M. Weber ^{b,c}, J. Valenzuela ^a, A. Zsakai ^l

^a Universidad de Granada, Granada, Spain

^b Consorcio IFMIF-DONES España, Granada, Spain

^c CIEMAT, Madrid, Spain

^d KIT, Karlsruhe, Germany

^e ENEA, Brasimone, Italy

^f CEA, Saclay, France

^g ENEA, Frascati, Italy

^h F4E, Garching, Germany

ⁱ Universidad de Castilla la Mancha, Ciudad Real, Spain

^j Ruder Boskovic Institute, Zagreb, Croatia

^k Uppsala University, Uppsala, Sweden

^l CER, Budapest, Hungary

^m ESS, Lund, Sweden

ⁿ IFJ PAN, Krakow, Poland

^o Empresarios Agrupados, Madrid, Spain

^p ESTEYCO, Madrid, Spain

^q UNED, Madrid, Spain

^r IREC, Barcelona, Spain

^s ANSALDO Nucleare, Genova, Italy

^t NCBJ, Świerk, Poland

ARTICLE INFO

Keywords:

IFMIF-DONES

Diagnostics

Instrumentation

ABSTRACT

The IFMIF-DONES Facility is a unique first-class scientific infrastructure whose construction is foreseen in Granada, Spain, in the coming years. Strong integration efforts are being made at the current project phase aiming at harmonizing the ongoing design of the different and complex Systems of the facility. The consolidation of the Diagnostics and Instrumentation, transversal across many of them, is a key element of this purpose. A top-down strategy is proposed for a systematic Diagnostics Review and Requirement definition, putting emphasis in the one-of-a-kind instruments necessary by the operational particularities of some of the Systems, as well as to the harsh environment that they shall survive. In addition, other transversal aspects such as the ones related to Safety and Machine Protection and their respective requirements shall be also considered. The goal is therefore to advance further and solidly in the respective designs, identify problems in advance, and steer the Diagnostics development and validation campaigns that will be required. The present work provides an overview of this integration strategy as well as a description of some of the most challenging Diagnostics and Instruments within the facility, including several proposed techniques currently under study.

* Corresponding author.

E-mail address: cltorregrosa@ugr.es (C. Torregrosa-Martin).

1. Introduction

The International Fusion Materials Irradiation Facility-DEMO Oriented Neutron Source (IFMIF-DONES) is a scientific infrastructure whose objective is to provide an intense neutron source (in the order of $1\text{--}5 \cdot 10^{14}$ n/cm²/s) for the qualification of materials to be used in future fusion power reactors [1]. Its implementation and exploitation is currently considered to be critical for the construction of the DEMONstration Power Plant (DEMO) [2,3]. Since the last years, the engineering design of the facility is being developed intensively within the framework of a work package of the EUROfusion Consortium (Work Package Early Neutron Source, WPENS), in direct collaboration with the Fusion for Energy organization [4]. The design of the facility is well progressing, accomplishing the preliminary design phase and currently within its detailed design phase [5].

IFMIF-DONES will be an accelerator-driven neutron source, based on a 40 MeV LINAC deuteron beam directed towards a liquid lithium target to produce neutrons by stripping nuclear reactions [1]. From the technological point of view, the facility is composed by three main elements:

1. Deuteron Accelerator: A 100 m length LINAC capable of accelerating a continuous wave (CW) deuteron beam with a nominal intensity of 125 mA up to 40 MeV. The output power of the accelerator is 5 MW [6].
2. Liquid lithium Target and loops: The Target will consist of a 25 mm thick liquid Li curtain or jet, circulating at 15 m/s inside the Target Vacuum Chamber (TVC), which is directly connected to the accelerator vacuum chamber. For providing such jet, a closed loop of liquid Li with a flow of 100 l/s is required. The Target accomplishes a double function; (i) it produces the required neutron field for samples irradiation and (ii) evacuates the 5 MW power deposited by the incident beam via heat exchangers and secondary cooling loops [7,8]. The rooms housing the Li loop will be in Ar atmosphere to provide inertization and minimize the risk of fires due to air–lithium reaction [7–9].
3. Irradiation Modules: Downstream the TVC, separated by a few millimeters, the so-called High Flux Test Module (HFTM) will house the material samples and specimens for irradiation [1]. The specimens shall be kept in a controlled temperature range within 250 and 550 °C [10] while continuously monitoring the neutron flux received. Both the TVC and HFTM are placed inside a leak-tight bunker, called Test Cell (TC), filled by He at a pressure of about 90 mbar to provide inertization as well as nuclear shielding and confinement [11].

In addition, these three main technological elements will be housed by the Main Building of the facility and supported by all the ancillaries and services necessary for their operation, including control systems, power supplies, HVAC, water and gas supplies, etc. [12]. A huge amount of Instruments and Diagnostics, fundamental for the operation of the facility, will be distributed across all these elements and connected to the respective Local Instrumentation & Control Systems (LICS) and the Central Instrumentation & Control System (CICS) [13].

In the context of the IFMIF Engineering Validation and Engineering Design Activities (EVEDA) project [14], several prototypes have been built and operated during the last decade, providing technical feedback that is being included in the IFMIF-DONES Design. Some of them are the accelerator prototype (LIPac) at Rokkasho (Japan) [15], the EVEDA lithium test loop at Oarai [16] and Li loop (Lifus6) in Brasimone [17], as well as the HFTM and irradiation capsules prototypes, including the testing of the latter in the Belgian BR2 test reactor [18,19].

In parallel to these prototype validations and design development, strong integration efforts are being made at the current project phase aiming at harmonizing the ongoing design of the facility. The engineering design of the IFMIF-DONES Plant is organized based on a so-called *Plant Breakdown Structure* (PBS). This structure divides the whole facility in 34 Systems, which are distributed within the following five Groups of Systems [5]:

1. Site, Buildings and Plant Systems.
2. Test Systems.
3. Lithium Systems.
4. Accelerator Systems.
5. Central Instrumentation and Control Systems.

This rationale is directly related to the construction strategy of the IFMIF-DONES, which is foreseen to be based on “in-kind-contributions”. This means that the corresponding Implementing Agencies to the Project will deliver each of these 34 Systems which, when assembled together, will shape the facility. This project strategy, while being a great enterprise of international collaboration for technological and financial synergies, entails also some challenges from the implementation point of view; namely, how to make sure that all the “puzzle pieces” of these 34 Systems will properly fit together at the end of the day. The only solution to success on this problematic is to have very well defined requirements, both in terms of Functional Requirements and Constraints. In addition, the definition of such requirements for the Diagnostics of the facility shall follow a transversal approach across these 34 Systems.

The main goal of this work is to provide a road-map and strategy to overcome the challenges associated to the Diagnostics definition of such a complex facility as IFMIF-DONES. In addition, it will provide an overview of some of the most technologically complex Diagnostics to be implemented, to illustrate the context to which this road-map shall be applied.

Two main types of challenges have been identified: (i) Organizational Challenges and (ii) Technical Challenges. Some of the Organizational Challenges are the following:

1. Management of an extensive variety of Diagnostics and Instruments across many systems, designed and manufactured by different groups, institutions and companies.
2. Keep a well-balanced requirements definition.
3. Keep the requirements traceability.
4. Keep an organized documentation to follow-up all the qualification procedures that will be needed during the construction.

while some of the Technical Challenges are:

1. One-of-a-kind facility needing specific Diagnostics and Instruments which are beyond the state-of-the-art in many cases.
2. Operation in harsh environments of radiation, temperatures and only remote handling (RH) access [1,20].
3. High availability requirements of the facility (70% operational availability [4,21]), which implies high reliability of components and very short and limited maintenance periods.
4. Many Safety and Machine Protection (MP) Diagnostics, subjected to strict reliability requirements in addition to their high impact on the facility availability [5,9].
5. Space for physical integration and cable routing, especially in the Test Cell.

Organizational and Technical challenges are inexorably entangled since it is not even possible to make a detailed technical requirements definition without a systematic organization. This work presents some proposals of techniques to overcome these challenges. Section 2 is focused on the Organizational Techniques, while Section 3 provides an overview of some of the most challenging diagnostics from the technical perspective. The purpose of future works will be to apply the methodology defined in Section 2 to provide a more systematic requirements definition of the Diagnostics presented in Section 3, among others.

2. Techniques for the Organizational Challenges

Three main ideas are proposed to overcome the Organizational Challenges:

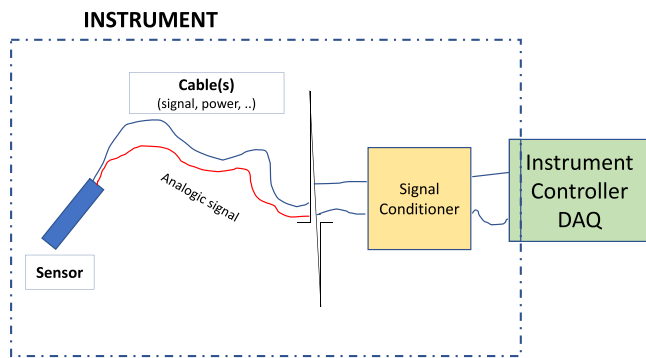

Fig. 1. Sketch illustrating the definition for the adopted nomenclature of *Instrument*, which includes (i) Sensor, (ii) Cable(s), (iii) Signal Conditioner, and (iv) Instrument Controller.

1. Use common nomenclatures and definitions: This should be something rather obvious but reality shows that this is not always the case when working in collaborative and delocalized projects. In this sense, the common definitions shall be made in such a way that highlight the transversal aspects and can cope with them. It is also considered quite useful to establish a clear difference between *Diagnostics* and *Instruments*, as explained in Section 2.1.
2. Define a methodology and common databases: The idea is to establish a methodology that puts emphasis on a Top-Down approach, which can help in the definition of Functional Requirements and Constraints while setting up their hierarchy and traceability. This methodology should arrive to the lowest level (sensor/probe), help in the documentation of the specific requirements for each instrument, and facilitate tracking the pursue of technical solutions. Finally, this methodology shall also help in the coordination and optimization of the R&D needs to reach such technical solutions.
3. Establish a standardization of components for the Local Instrumentation & Control Systems (LICS): This technique, even if more prominent during the design and implementation phase, aims at considering the use of common solutions right from the beginning of the requirement definition phases, such as the same commercial Off-The-Shelf (COTS), whenever possible. This technique is being achieved by also creating common databases of LICS components, and imposing these guidelines to the in-kind contributors.

The following three subsections develop further these ideas.

2.1. Use of a common nomenclature

It is clear that a common nomenclature is a basic aspect of organization and communication. Nevertheless, this cannot be achieved if there are not common definitions behind. For the integration activities of IFMIF-DONES, the following three key definitions are proposed: (i) *Instrument*, (ii) *Instrument Set* and (iii) *Diagnostic*.

2.1.1. Definition of Instrument

The simplest definition of *Instrument* would be a device that measures something. Nevertheless, the following question that may arise is where are the boundaries of this device. In this work, the definition illustrated in Fig. 1 is proposed. An *Instrument* comprises: (i) Sensor, (ii) Cable(s), (iii) Signal Conditioner, and (iv) Instrument Controller (at least partially). The sensor would be the part of the *Instrument* in which a physical variable is converted into an electric signal. The output of the sensor would be in principle always analogic, unless specified (digital sensor). The signal conditioner would be the device that manipulates

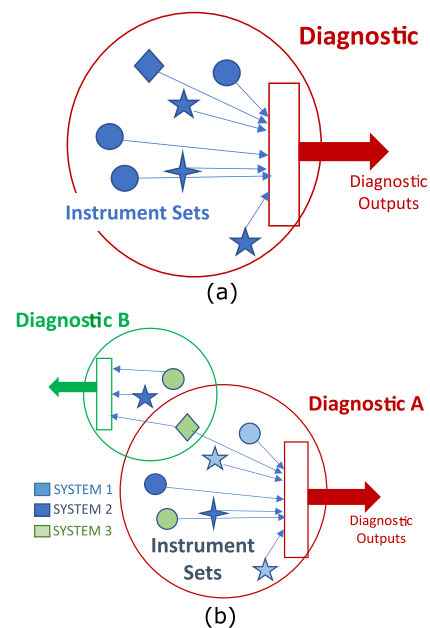

Fig. 2. Schemes illustrating the definition of *Diagnostic* proposed in this work. (a) Different *Instrument Sets* (geometrical figures), representing different gauges (flowmeter, thermocouples, radiation monitors, etc.), feed a *Diagnostic*. (b) The same *Instrument Set* may feed more than one *Diagnostic*. A *Diagnostic* can be fed by *Instrument Sets* belonging to different Systems in the project PBS (represented by different colours).

the analogic signal in such a way that meets the requirements of the next stage of further processing. Finally, the Controller would be in charge of acquiring the signal and process it. The boundary of the *Instrument* crosses the Instrument Controller but does not fully cover it necessarily, since the Controller may have other functions beyond such *Instrument*. An example of *Instrument* could be a type-K thermocouple that is installed at a given position in the Target Assembly.

2.1.2. Definition of Instrument Set

While *Instrument* may refer to a specific device, we define *Instrument Set* as a set of devices (*Instruments*) of the same kind/model which share their function and/or are subjected to the same requirements. An example of *Instrument Set* could be all the type-K thermocouples of the brand xxx that are installed around the Target Assembly.

2.1.3. Definition of Diagnostic

Alternatively, the definition of *Diagnostic* that we propose is slightly more complex than the one of *Instrument* or *Instrument Set*. A *Diagnostic* would imply the characterization of a functional feature by means of one or several *Instruments/Instrument Sets* and the use of these measurements for running the machine. For this reason, *Diagnostic* involves some extent of logic and post-processing of the *Instrument* measurements by, for instance, putting these measurements into context within a System (i.e. position, operational mode, function), by combining multiple measurements, by providing values of the expected measurement, or by including thresholds relevant for operation (i.e. alarms, interlocks). This definition implies that several *Instrument Sets* of different kind can for instance feed a *Diagnostic*. This is illustrated in Fig. 2-(a) in which each geometric shape represents a different *Instrument Set*. An example of *Diagnostic* could be the *Test Cell Atmosphere Diagnostics* whose function is to characterize the atmosphere in the Test Cell. To do so, multiple *Instrument Sets* such a pressure gauges, thermocouples, flowmeters, radiation monitors, etc. would feed this *Diagnostic*. Other features of this definition are illustrated in Fig. 2-(b), such as:

Grouping Instruments within Hierarchical Diagnostic Families

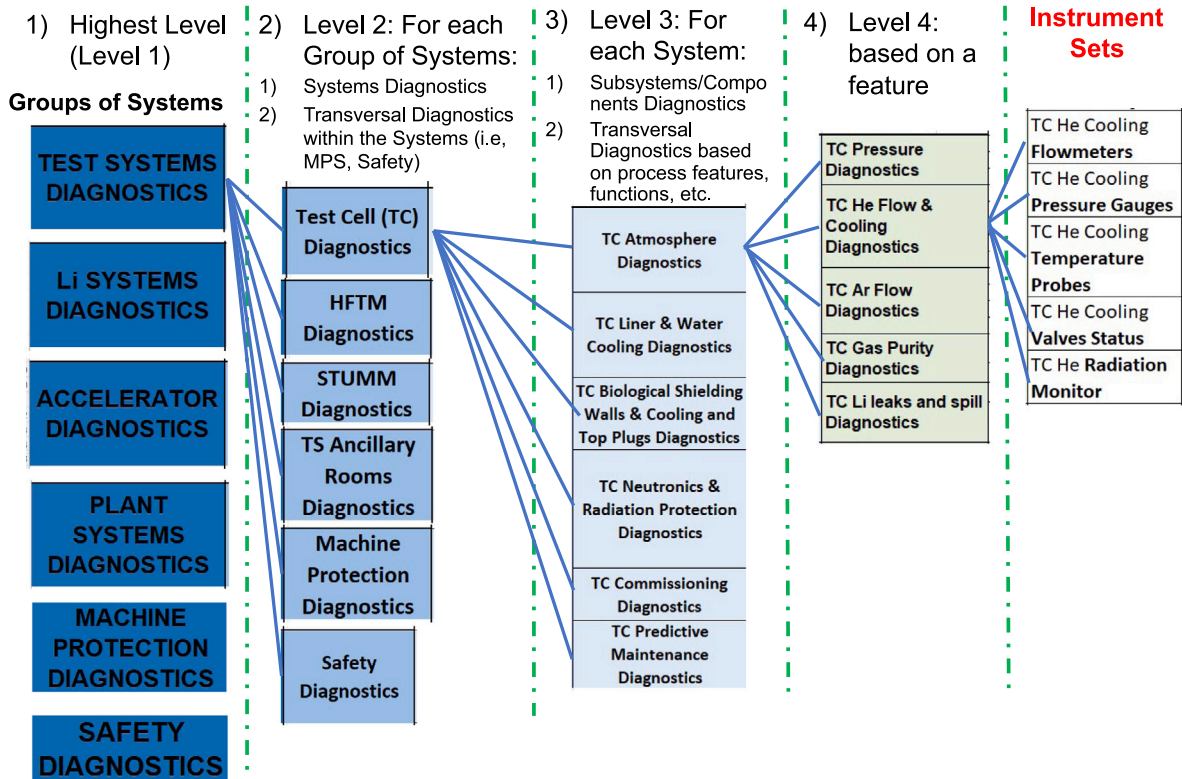

Fig. 3. Figure illustrating some hierarchy of Diagnostic Families to be used for the creation of requirements and instruments databases. At the lowest level, the example shows the Instrument Sets that would feed the “Test Cell He Flow & Cooling Diagnostic” (such as flowmeters, pressure gauges, temperature probes, valve Status). This Diagnostic will be then part of the “Test Cell Atmosphere Diagnostics”, which is part of the “Test Cell Diagnostics” and, at the top level, of the “Test Systems Diagnostics”.

- The same Instrument Set could feed different Diagnostics as it may be useful to characterize more than one functional feature. This is represented in Fig. 2-(b) where the green rhombus is connected to Diagnostic A and Diagnostic B. An example of this could be the neutron detectors placed in the irradiation modules (HFTM): Its main function is to characterize the neutron field applied to the material samples but it may be useful as well to characterize or detect an abnormal condition in the Li Target, since a change in the Li jet may affect the neutron field downstream. Another more conventional example could be the flowmeters and thermocouples placed around the Li-Oil heat-exchanger in the Li loop: These Instrument Sets may belong to the Primary heat-exchanger Diagnostics to monitor the correct operation of this device and, at the same time, feed the Li Loop Power Diagnostics, since their measurement may be used to infer the average beam power on the Target.
- The other feature has to do with the transversality that this Diagnostic definition provides across the project PBS boundaries. For instance, a Diagnostic could be fed by Instrument Sets belonging to different Systems according to the PBS. This is also illustrated in Fig. 2-(b) by the different colours of the Instrument Sets. This aspect will be present in many Diagnostics. For example, in the Test Cell Atmosphere Diagnostics there may be some Instrument Sets belonging to the TC Liner System (such as thermocouples or pressure gauges attached to it), while others instruments belonging to the Test System Ancillaries (such as flowmeters of the He supply and recirculation). Another very remarkable example of transversal Diagnostics are the ones related to the Machine Protection (MP) or Safety Diagnostics, that will be fed by Instruments belonging to very different Systems.

The use of this nomenclature is the base to understand the methodology for creating a Hierarchical Database for the Diagnostics of Instruments of the Facility, described in the following section.

2.2. Hierarchical database for requirements definition

As explained in the introduction, one of the main challenges is to provide a comprehensive set of well-balanced requirements for the extensive number of Diagnostics and Instruments of the facility while keeping traceability and transversality. For doing so, a Top-Down strategy is proposed based on the creation of a multi-level hierarchy of Diagnostic Families, as illustrated in Fig. 3, focused on functional features. Up to two four levels of Diagnostics are proposed:

- I At the highest level the Diagnostics are classified according to their belonging to Groups of Systems, such as Test Systems, Lithium Systems and Accelerator Systems, in addition to fully transversal Diagnostics such as Machine Protection and Safety Diagnostics.
- II At the level two, it is possible to find Diagnostics related to the Systems-level PBS as well as other transversal ones within the system (i.e. MPS, Safety).
- III At the level three there would be some Diagnostics related to Subsystems and Components, while others transversal to them based on processes and features (i.e. neutronics, power, predictive maintenance, commissioning).
- IV Finally, at the level four there would be the Diagnostics based on specific monitoring features (i.e. flow monitoring, pressure monitoring, neutron field monitoring, etc.), for which different measuring technologies or principles may be used.

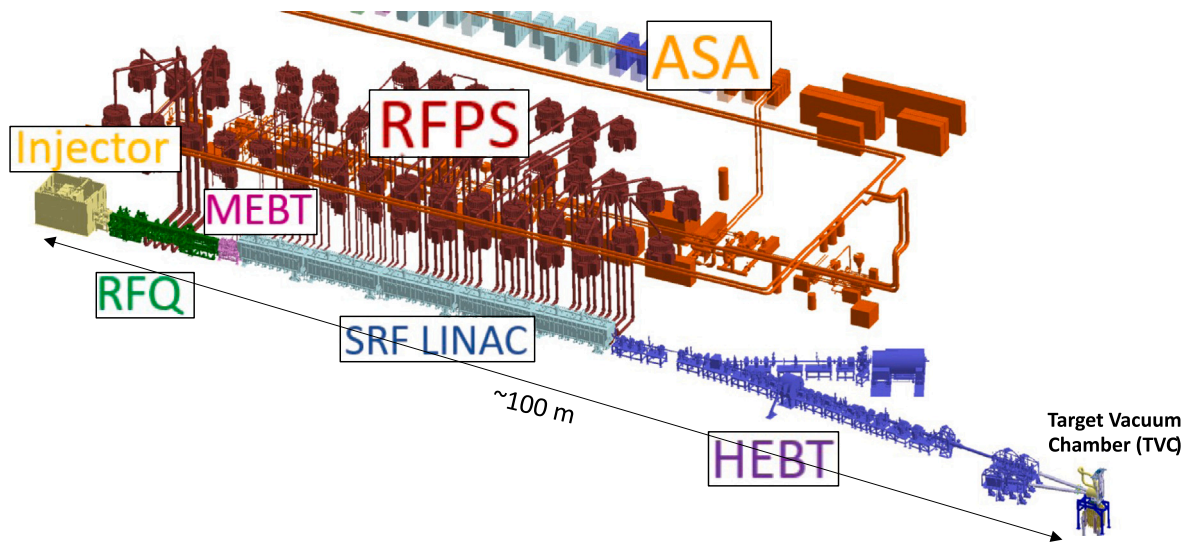

Fig. 4. Integrated mock-up of the IFMIF-DONES Accelerator Systems, highlighting its seven Systems [6].

For each of these *Diagnostic Families*, Functional Requirements and Constraints are defined, which are then propagated to their descendants. Attached to the lowest level of Diagnostics there would be *Instrument Sets*, which will inherit all the Requirements and Constraints from their *Parent Diagnostics*. In addition, an *Instrument Set Datasheet* will be created, containing information of both the Requirements and Constraints as well as the technical solution proposed so far. In this way, it will be easier to follow-up if a proposed solution of *Instrument* fulfils the requirements (such as range, accuracy, time-resolution, reliability, resistance, maintainability, etc.) and design the qualification procedures accordingly.

2.3. Standardization database for Local Instrumentation and Control Systems

The third leg to overcome the organizational challenges is the use of common guidelines for the design characteristics and component selections of the Local Instrumentation and Control Systems. This is done by the compilation of a “LICS Guideline Handbook” and “Common Components Database”, which would apply not only to instruments, diagnostics and their DAQs, but also to controllers, actuators, PLCs, cubicles, etc. The idea is to minimize, whenever possible, the technological differences between Instrumentation and Controls Systems (and therefore, between Diagnostics). The goal of this standardization is to homogenize the designs to reduce problems of integration, maintenance, costs, trouble shooting and for assuring and maintaining the knowledge and expertise over different systems along the facility life-cycle.

3. Overview of some challenging IFMIF-DONES diagnostics

In this section we provide a summary of some of the most challenging Diagnostics from the technical point of view that have been identified, as well as some proposed solutions that are currently under study. Diagnostics within three main Groups of Systems will be described; Accelerator Systems, Lithium Systems and Test Systems.

3.1. Accelerator Systems (AS)

Fig. 4 shows a scheme of the IFMIF-DONES Accelerator [6]. It will consist in a 40 MeV CW Deuteron Accelerator powered by 175 MHz Radiofrequency Systems (RFPS). It will have a nominal intensity of 125 mA and an output power of 5 MW (delivered to the Target). It shall have an inherent availability (i.e., over the scheduled operation time)

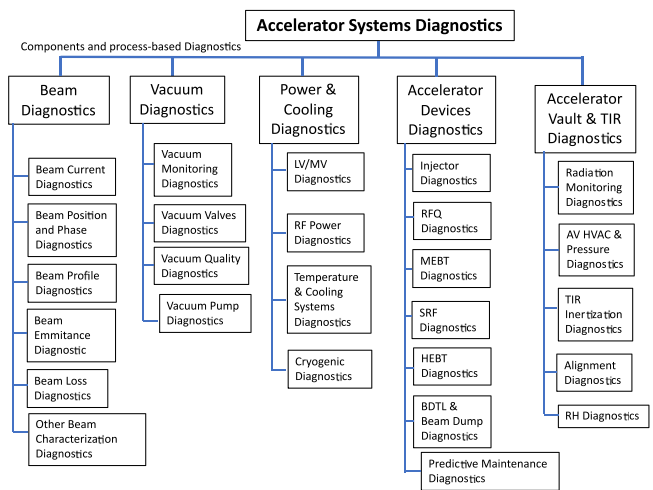

Fig. 5. Preliminary *Diagnostic Families* classification (Levels II and III) for the Accelerator Systems following the methodology introduced in Section 2.

of 87% [21]. The current project PBS defines the following Systems within the Accelerator Systems:

- Injector Source.
- RadioFrequency Quadrupole (RFQ).
- Medium Energy Beam Transport Line (MEBT).
- Superconducting Radiofrequency (SRF) LINAC.
- High Energy Beam Transport Line (HEBT), which includes the beam dump (BD).
- Radio Frequency Power System (RFPS).
- Accelerator Systems Ancillaries (ASA), which include the supply of cryogenics, vacuum, water cooling, low voltage and medium voltage electrical distribution, as well as gas distribution.

Regarding the Diagnostics of the Accelerator Systems, a *Diagnostic Family* classification has been proposed following the methodology introduced in Section 2. Fig. 5 shows an overview of this first proposal for the top level Diagnostics families (Levels II and III). At the Level II the following *Diagnostic Families* are proposed: (i) Beam Diagnostics, (ii) Vacuum Diagnostics, (iii) Power & Cooling Diagnostics, (iv) Accelerator Devices Diagnostics, (v) Accelerator Vault & TIR Diagnostics. It is worth to emphasize the transversality of these *Diagnostic Families* with

respect to the to seven Systems of the AS defined in the PBS. For instance, the *Instruments* of the Beam Diagnostics will be distributed across all the systems of the beam line (Injector Source, RFQ, MEBT, HEBT), same as Vacuum Diagnostics. In addition, many *Instrument Sets* will be part of different *Diagnostics*. For example, the Beam Position Monitors (BPMs) distributed within the specific “Accelerator Devices Diagnostics”, will be also part of the “Beam Diagnostics”. Finally, it is worth noting to remark other transversal Diagnostics such as the Machine Protection Diagnostics or Safety Diagnostics, which will have also *Instruments* distributed across these families (even though they are not shown in Fig. 5).

The next subsections describe some technical challenges of the Accelerator Systems Diagnostics and several technical solutions under study.

3.1.1. Beam current, position and profile monitoring

The main challenges are related to the high accelerator current and power that requires the development of specific Beam Diagnostics solutions [22–24]. In addition, other challenges are related to the limited space, high reliability, maintenance by Remote Handling (RH) means, and high radiation in the last 20 m of the accelerator (close to the Target). Some examples of Beam Diagnostics are:

- SRF-LINAC Beam Diagnostics: The components of the SRF-LINAC shall be tightly packaged due to the high beam space charge. For this reason, the lack of diagnostics makes the commissioning and tuning very challenging in this area where the beam power density is the highest of the whole accelerator and the equipment is susceptible to thermal quenches. Button-type Beam Position Monitors (BPMs) are foreseen to measure the beam centroid. The design is based on the LHC design, capable of operating at cryogenic temperatures. In addition, transverse profile monitors are also required and they shall be installed at warm sections between the five cryomodels. Only interceptive monitors are possible. Current design solution is based on SEM-Grids that could only operate at intensities below 75 mA during commissioning phases.
- HEBT and Beam Dump Transport Line (BDTL) Beam Diagnostics: Diagnostics are installed at the HEBT line to ensure a correct delivery of the beam coming from the SRF-LINAC to the Li Target with the nominal current, energy, position and profile. During nominal operation the BDTL is not used since the beam goes to the Target. However, during machine start and tuning of the upstream systems the beam is deviated through the BDTL to the dump, where is stopped. Specific beam monitors for 6D characterization shall be developed in the BDTL. This includes beam current, position, transverse profile, bunch length and beam losses. Some of the instruments are quite clear and have been qualified at LIPAc, such as ACCT (AC Current Transformer), BPM, SEM Grid and IC (Ionization Chambers). Nevertheless, others shall still be validated such as Continuous Wave Current Transformer (CWCT), Fluorescence position monitors (FPM) or Residual Gas Bunch Length Monitor (RGBLM), which is key for the beam longitudinal characterization.
- HEBT Beam Diagnostics at the Target Interface Room (TIR): Characterization and monitoring of the beam profile that is sent to the Target is essential for a safe and reliable operation. This characterization shall be done as close as possible to the Target, which is the TIR (around 6 to 10 m upstream) [23,25]. The absorbed radiation doses in this room are estimated within 1 to 5 MGy/fpy jeopardizing the life and reliability of many instrument solutions. Only RH maintenance is allowed. Main characteristic to be measured is the beam position and size of the transverse footprint on the Target. The proposed solution relies in a combined method by optical diagnostics and a RF pickup. The optical diagnostic (also mentioned in Section 3.2.2), would

be based on a camera pointing towards the Li Target through an optical path in a secondary beam line, aiming at recording the Optical Transmission Radiation (OTR) produced when the beam impinges the Li. This direct observation of the beam on the Target would be used during commissioning for tuning the beam profile. Once the nominal beam profile is set at the Target level, the RF pickup, placed in the TIR, could be calibrated and record continuously during operation. There are currently some planned experiments to verify this approach using liquid Li and a e-gun (10.5 keV) to obtain charged particles equivalent to the 40 MeV deuterons.

3.1.2. Beam Loss monitoring

Another challenging aspect of the Accelerator Diagnostics is related to the Beam Loss monitoring due to the particularities of the losses to be detected and the fast response time required (around 10 μ s). Four types of beam loss monitoring may be present:

- Neutron Beam Loss Monitors (nBLM): In some cases it is very difficult to measure beam losses of hadronic beams at low beam energies since they are shadowed by RF emissions (gammas, x-rays) at high intensity operation. To do so, nBLM in which the signal is produced by fast neutrons is proposed. Detectors have been designed to be sensitive to neutrons while having a very low efficiency to gammas and x-rays. The proposed nBLM detectors are based on Micromegas (Micro-MESH Gaseous Structure) technology [26], recently used also in ESS [27].
- Micro Beam Loss Monitors (μ BLM): Undesired micro beam losses, apart from decreasing the beam current, lead to activation of the pipe walls complicating maintenance as well as increasing the risk of SRF quenches due to heat deposition. The goal of DONES is to keep those micro losses below 1 W/m. To do so, the instrument should be able to distinguish between real losses and normal background. The current μ BLM monitors proposal are based on CVD diamonds, as the ones already tested in LIPAc [28].
- IC Beam Loss Monitors (BLoM): Greater losses such as the ones in the case of mis-steering, magnet or cavity failure will be measured by IC, based on the LHC ones [29].
- Prompt Radiation Monitor: Finally, another instrument that shall be developed is related to the actuation of Safety Beam Interlocks in case of prompt radiation produced by a destructive mis-steering event. This instrument shall trigger a safety shutdown of the beam before the prompt radiation in adjacent rooms (where personnel may be present) are above radio-protection limits. The difference with the previous monitors (which will feed the MPS) is that this instrument will be subjected to more strict reliability requirements since it will be a Safety Class Component. On the other hand, slower reaction times may be required to this monitor (in the order of hundreds of milliseconds).

3.1.3. Fast response vacuum monitoring

Finally, another remarkable aspect regarding challenging Diagnostics of the AS has to do with fast vacuum monitoring. This is due to the Safety role that some of the pressure gauges would play to mitigate postulated accident scenarios related to the sudden gas inrush inside the vacuum chambers. One of the particularities of the IFMIF-DONES Accelerator is that there cannot be a separation window with the Target Vacuum Chamber. This implies that contact of air and liquid Li could take place in case of failure of the Target Vacuum Chamber (TVC) or a destructive air leak upstream in the accelerator. The mitigation plans foresee the use of Fast Isolation Valves (FIV) as close as possible to the TVC with actuation times in the order of 100 ms. Fast acquisition vacuum gauges such as cold-cathode and glow-discharge are foreseen (response time around 1 ms) to trigger the actuation of such valves. Main aspects to be clarified are the reliability of these devices to be used as Safety Class Components as well as their performance under

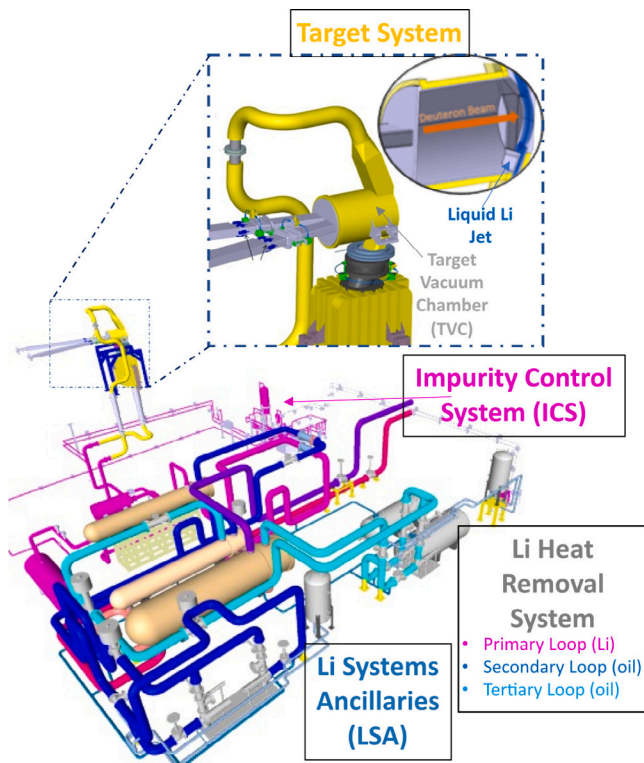

Fig. 6. Mock-up showing the Lithium Systems. The four Systems belonging to this Group of Systems are highlighted.

the high radiation close to the TVC. In addition, the gauges response at the operating pressure range of $10^{-5} - 10^{-4}$ mbar of the TVC shall be verified. A prototype is currently under construction in the University of Granada to verify these aspects, called Multipurpose Vacuum Accident Scenarios (MuVacAS) test-bench.

- Target System.
- Li Heat Removal System: Consisting in the primary Li loop, and two additional oil loops (Secondary and Tertiary Loops) connected through Heat-Exchangers (HX).
- Li Impurity Control System.
- Li Systems Ancillaries (LSA): Including the supply of heating to the Li, gas and vacuum supply for the loop operation, and electric power.

3.2. Diagnostics in Lithium Systems

Fig. 6 shows a scheme of the IFMIF-DONES Lithium Systems. Its main goal is to provide a stable liquid Li jet (or curtain) circulating at 15 m/s and 300 °C inside the TVC, on which the deuteron beam will impact. Most of the 5 MW beam power will be deposited in the jet and evacuated with its flow. For this reason, the jet thickness along the beam direction (25 mm) is of paramount importance to avoid depositing power in the downstream back-plate of the TVC, which would imply its rupture. The required Li flow to keep this jet thickness is 100 l/s and will be provided by Electromagnetic pumps (EMPs) based on permanent magnets. The control of impurities in the Li is also a key aspect to avoid corrosion and for radio-protection. A parallel loop retrieving 2 l/s shall continuously purify the Li by using different types of traps (H traps, cold Traps and N Traps) as well as to monitor the impurity content. During operation, all the rooms housing Li pipes will be inertized by means of Ar atmosphere (Li Loop Cell). The Fig. 6 highlights the TVC within the Target System that will be placed inside the Test Cell (TC) as shown in Fig. 8. A yearly exchange of the Target

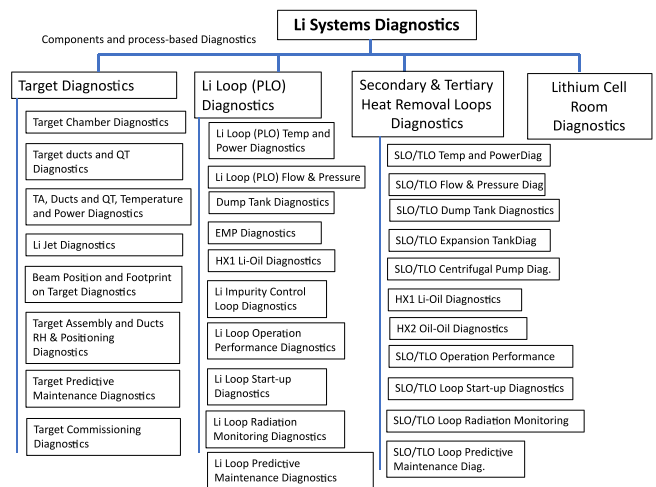

Fig. 7. Preliminary Diagnostic Families classification (Levels II and III) for the Lithium Systems following the methodology introduced in Section 2.

is foreseen and shall be fully performed by RH means due to the high activation of all its components. The figure also shows the Primary, Secondary and Tertiary loops located in the rooms below the TC.

The current project PBS defines the following main Systems within the Lithium Systems:

Regarding the Diagnostics of the Lithium Systems, a Diagnostic Family classification has been proposed following the methodology proposed in Section 2. Fig. 7 shows an overview of this first proposal for the top level Diagnostics families (Levels II and III). At the Level II the following Diagnostic Families are proposed: (i) Target Diagnostics, (ii) Li Loop Diagnostics, (iii) Secondary & Tertiary Loops Diagnostics, (iv) Lithium Cell Room Diagnostics. This Diagnostic Families are highly transversal to the PBS as they are more process-based rather than System-based.

The next subsections describe three technical challenges of the Lithium Systems Diagnostics and some technical solutions under study.

3.2.1. Diagnostics for the characterization of the Li jet thickness

As already introduced, monitoring the 25 mm Li jet thickness is critical to avoid damaging the back-plate of the Target Vacuum Chamber. It is estimated that there is only a 2 mm detection margin within the reduction along this thickness to avoid the back-plate damage, and that it shall be detected within the order of milliseconds. In addition, the extremely high radiation present during operation (above 10^4 MGy/fpy Si-equivalent) disables the use of any local means of measuring. Currently, three methods of measuring the Li jet thickness are under consideration:

- Use of Laser Interferometry: This system would be similar to the one proposed of the In-Vessel Viewing System (IVVS) in ITER [30]. It would profit from the secondary line to the TVC to point a laser to the Li through a mirror and optical fibres [31] so the interferometer acquisition could be placed far enough and shielded from the radiation. This system would provide a sampling frequency above the kHz range but relies of the presence of wake waves on the Li jet to improve the reflected signal. Experimental campaigns using GaInSn as liquid metal are currently ongoing.
- Use of a Radiofrequency based Diagnostic: A diagnostic based on mmWave radar techniques is currently under study by pointing an antenna towards the Li Target. This system could be a compact and resistant solution for the extremely harsh environmental conditions and could allow the integration of the antenna in the TVC as it is a passive component. The radar transceiver and the

rest of electronic devices could be placed separated from antennas by means of waveguides.

- Use of the response of neutron or/and gamma monitors placed in the HFTM: Finally, another possible solution would be to rely on detecting a variation in the radiation field downstream the Target as a consequence of the Li jet thickness reduction and corresponding change in the interaction length. Radiation monitors such as the ones described in Section 3.3.1 could be used if their sensitivity and fast response is high enough.

3.2.2. Characterization of beam impact position on target

As already introduced in the Accelerator Diagnostics, it is very important to monitor the beam impact position on Target and its footprint to avoid its miss-steering towards the TVC walls. The nominal beam footprint size is 50×200 mm while the Li jet is 260 mm wide, leading to a 30 mm margin at both sides. Significant deformations may occur in the TVC due to pressure differences and thermal expansions since it reaches temperatures close to 400 °C. Therefore, a direct measurement of the beam impact position is very important to steer the beam and detect any eventual change. The solution currently under study is the use of a camera pointing to the jet through an optical path to record the OTR emitted on the Li surface when the deuteron beam impacts, as introduced in Section 3.1.1.

3.2.3. Characterization of Target and Loop Operation Performance

Operation of liquid metals implies several technological complexities. In case of IFMIF-DONES these complexities are accentuated by multiple particularities such as loop activation, limited and RH maintenance, free Li surface at vacuum in the Target, extremely high radiation around the Target and Safety implications among others. Some of the challenging Diagnostics and Instruments considered to characterize the Target & Loop Operation Performance are the following:

- Li flowmeters and pressure gauges: Several types of flowmeters shall be installed along the Li loop. Some of them will be based on Venturi flowmeters while electromagnetic EM flowmeters are also considered as they may provide a higher time resolution to mitigate eventual flow instabilities that may affect the Li jet. Some of these flowmeters will be part of the MP system and even Safety system so they will be subjected to high reliability and qualification requirements.
- Levelmeters: Li levelmeters will be present in several volumes along the loop such as the Li dump tanks and the quench tank (the latter situated underneath the Target Assembly). Instruments based on electric contact are considered, as well as differential pressure gauges. The most challenging levelmeters will be the ones of the quench tank as they will be subjected to absorbed doses in the order of 40 MGy/fpy and their maintenance and RH replacement will be quite complex since the quench tank exchange during operation is not foreseen.
- Li Leak detectors: Li leak detectors based also on electric contact will be installed at connection flanges of the Li piping, both around the Target and in the Li loop cell. The idea is to use a similar technology as the one employed at SNS neutron source in ORNL [32].
- Heaters and temperature probes: Radiation-hard heaters and type-K thermocouples shall be installed around the Target assembly and Li loop piping to reach the required temperatures for allowing liquid Li circulation at 300 °C in the cold leg.
- Vacuum pressure measurement in the TVC: The vacuum pressure inside the TVC shall be kept in a very limited range of $10^{-5} - 10^{-4}$ mbar. Higher pressures would lead to unaccepted beam losses while undesired Li evaporation may occur at lower pressures. An Ar injection system in the TVC to provide a differential pressure system along the beam vacuum line is foreseen for this purpose. Ideally, the installation of a vacuum gauge in the TVC to control

and monitor such pressure would be required. The challenge is the high radiation environment (above 100 MGy/fpy) around the TVC and the lack of vacuum gauges technologies that provide high accuracy measurements within this range.

- Li evaporation detectors: An instrument based on Cavity Ring-down Spectroscopy (CRDS) is under study to detect eventual Li evaporation within the accelerator vacuum chambers that could redeposit and damage upstream vacuum gauges, gate valves sealings or other components. This instrument would be installed in a cavity profiting from the secondary beam line.

3.2.4. Characterize Li purity, and performance of the impurity control system

Impurities content in the Liquid Li such as N, O shall be kept in the order of tens ppm. In addition, other radionuclides such as the Be-7 and tritium produced in the stripping reactions in the Target as well as Activated Corrosion Products (ACPs) shall be also removed [33]. Due to the low concentrations involved, the baseline scenario considers the characterization of these impurities via offline analysis by periodical extraction of Li samples. Other proposed online methods under consideration include a Resistivity Meter for online N monitoring [34] and a Electro-Chemically based H sensor [35].

3.3. Test Systems

Fig. 8 shows a scheme of the IFMIF-DONES Test Systems. This Group of Systems involves all the elements required for the material samples irradiation as well as to provide shielding and confinement around the Target and irradiation modules. As shown in Fig. 8, the irradiation module is placed downstream the Target separated by a few millimeters from the Target back-plate. Two types of irradiation modules are designed; (i) the High Flux Test Module (HFTM) and (ii) the Start-up Monitoring Module (STUMM) [36]. The external assemblies of both modules are quite similar while their content is different. The STUMM will be only used during commissioning phases and for this reason is equipped with a large number of instruments and does not house any material sample. Alternatively, the HFTM will be used during irradiation operation and will house hundreds of miniaturized material specimens. In addition, the HFTM shall provide means for a controlled irradiation temperature of the specimens within 250 and 550 °C. This is done by heaters and a He cooled minichannels [37,38]. Both the Target and Irradiation Modules are placed inside a shielding bunker, called the Test Cell. The inner walls of the Test Cell are made of a leak-tight, water-cooled steel vessel called the TC-Liner. During operation this liner is filled by He at around 90 mbar absolute in order to provide an under-atmospheric pressure radiological barrier. All the cables routing for the Target Assembly, HFTM/STUMM and instrumentation inside the TC-Liner shall be done by means of leak-tight feedthroughs at the top shielding plugs of the TC bunker. The current project PBS defines the following main Systems within the Test Systems:

- Test Cell System.
- High Flux Test Module (HFTM) System.
- Start-up Monitoring Module (STUMM) System.
- Test Systems Ancillaries (TSA): Including the supply of water cooling for the Liner and shielding blocks, He gas cooling and purification for the TC inert atmosphere, He gas cooling for the HFTM/STUMM and electrical power supply to all the Test Systems.
- Facilities for Complementary Experiments.

Regarding the Diagnostics of the Test Systems, a Diagnostic Family classification has been proposed following the methodology proposed in Section 2. Fig. 9 shows an overview of this first proposal for the top level Diagnostics families (Levels II and III). At the Level II the following main Diagnostic Families are proposed: (i) Test Cell Diagnostics,

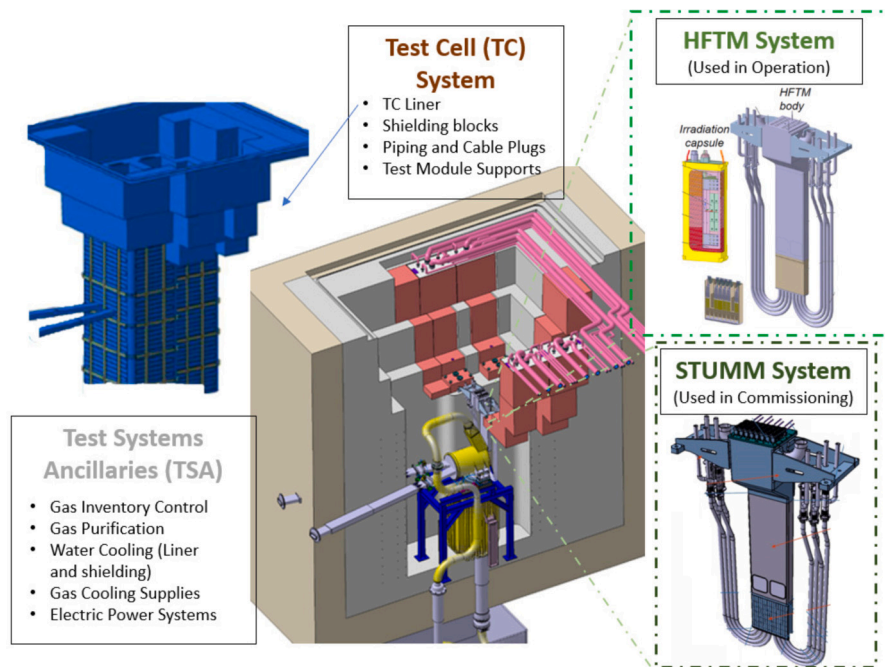

Fig. 8. Sketch showing the Test Systems. The four Systems belonging to this Group of Systems are highlighted.

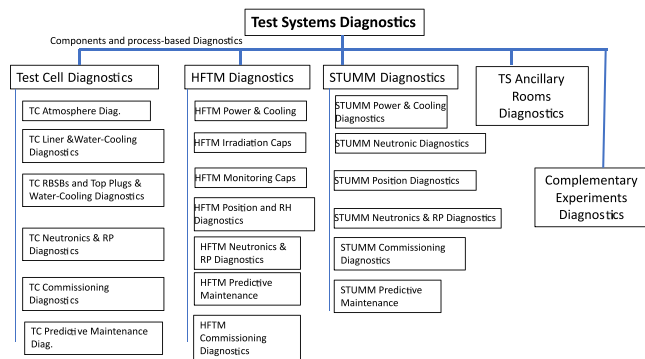

Fig. 9. Preliminary Diagnostic Families classification (Levels II and III) for the Test Systems following the methodology introduced in Section 2.

(ii) HFTM Diagnostics, (iii) STUMM Diagnostics and (iv) Test System Ancillary Rooms Diagnostics. A good example of the transversality of this classification across the PBS is present in the Test Cell Diagnostics: in the PBS, the TC includes the TC-Liner, shielding walls, upper plugs, etc., but most of the instruments required for their operation (such as cooling loops flowmeters, pressure gauges, etc.) belong to the TSA. This separation is surpassed by the Test Cell Diagnostics Family since it is process-based.

From a general perspective the main challenges are related to the fact that the Test Cell will be closed during operation and only opened a few days per year. All the instruments will be exposed to very high radiation, some of them in the range of absorbed doses above $2 \cdot 10^4$ MGy/fpy Si-equivalent for the HFTM and STUMM instrumentation, and within 30 MGy/fpy and 400 MGy/fpy around the TC-Liner walls and cable connectors. Very limited space will be available for cable routing integration with the risk that electric noise due Electromagnetic Compatibility (EMC) may jeopardize the instrumentation measurements. In addition, all the maintenance shall be carried out by RH means. Reliability of the instruments installed is essential for the success of irradiation campaigns as well as for Safety licensing and to avoid MP overacting. The next subsections describe more in detail two

technical challenges of the Test Systems Diagnostics and some technical solutions under study.

3.3.1. Characterization of neutron fields

The top requirement of the IFMIF-DONES facility is to irradiate material specimens at equivalent conditions as the ones present in future fusion reactors such as DEMO. The expected neutron flux in IFMIF-DONES will be in the order $5 \cdot 10^{14}$ n/cm²/s with a broad peak at 14 MeV and with 80% of them above 1 MeV [39]. Neutrons fields shall be characterized with enough accuracy and precision, maintaining the neutron field calibration along the irradiation campaigns. The spatial resolution required is in the order of 10 mm and time resolution within 10 μs. The radiation monitors considered for neutron fields characterization within the HFTM/STUMM are the following:

- Self-Powered Neutron Detectors (SPND): These neutron detectors are widely used in nuclear reactors to monitor the thermal neutron flux. Their use in IFMIF-DONES is considered for both the HFTM and STUMM. These detectors use the β-decay process of its neutron-activated material to produce an output signal, which can be measured directly with an ammeter. The challenges come from the high operational temperatures of the HFTM (250–550 °C), the low expected signals in the order of nano-amperes, and their low sensitivity for fast neutrons due to limited cross section of the emitter elements. R&D Activities using the GELINA source and CERN’s nTOF have been carried out to test different solutions at fast neutrons environment and more will follow [40].
- μFission Chambers (U238/U235) coupled with Ionization Chambers (ICs): Miniaturized gas ionization chambers coated by U238 or U235 (μFCs) are proposed to characterize fast and thermal neutron spectrum respectively. Their use is foreseen for the STUMM operation. These chambers will be used in combination with ICs of the same geometry to discriminate the electric signal produced by gammas. Irradiation, calibration and validation campaigns with these setups for IFMIF-DONES were performed in the BR2 reactor [41,42]. More irradiation campaigns are foreseen in the context of the prototype STUMM-PROTO, currently under construction in the University of Granada.

- γ – Thermocouples (GTs): Another technique under study is the use of GTs in the STUMM that shall be manufactured on demand according to the expected nuclear heating parameters and cooling conditions.
- Activation foils and Rabbit-Activation balls: Finally, other technique under study for neutron field characterization is to use offline methods. Activation foils would be included in several parts of the irradiation modules and the TC-liner walls to be retrieved by RH means during maintenance periods. The aim is to use them as the most accurate mean of measuring the integral neutron fluence received by the specimen samples [43]. Thus several activation foils would be attached to the HFTM capsules in order to obtain the spatial neutron flux distribution after each irradiation campaign. In addition, the use of activation-balls to be retrieved during operation by a pneumatic rabbit is also under study for the STUMM. These technique would also allow the characterization of the radiation energetic spectrum, which cannot be easily done by μ FC and IC.

3.3.2. Characterize temperatures and deformations of the HFTM/STUMM

The irradiation temperature is a key parameter in the radiation damage processes of the material specimens. Irradiation campaigns at temperatures within 250–550 °C are foreseen. A carefully and reliable temperature control of the irradiation capsules by means of heaters and type-K thermocouples is required. Temperature measurements may be also needed for Machine Protection Systems to actuate in case of HFTM assembly overheating. In addition, thermal expansions and deformations due to pressurization of the HFTM cooling systems may jeopardize spatial accuracy of the irradiation. This monitoring shall be done at an environment with absorbed doses above 10^4 MGy/fpy Si-equivalent while keeping a stable calibration in case of measurements shifts.

3.3.3. Characterize alignment and relative position of target and HFTM/STUMM

Keeping a constant distance and alignment between the Target and the HFTM/STUMM assemblies is of paramount importance for a successful irradiation. Relative displacements may occur due to the non-uniform temperature fields (reaching service temperatures up to 400 °C in the TVC and 150–200 °C in the HFTM external assembly). Other sources of relative displacements may be the TC-liner deformations due to low pressure operation and HFTM/STUMM pressurized cooling systems. The TC bunker will be closed and depressurized during commissioning and operation preventing any direct measurement and fiducialization of components inside. Some of the methods under consideration to monitor these displacements are:

- Linear Variable Differential Transformers (LVDTs): This passive displacement measuring system may be placed on the sides between the Target Assembly back plate and the HFTM/STUMM, as widely used in many mechatronic systems in particle accelerators [44]. Although radiation campaigns shall be performed to verify their resistance when exposed to the hundreds of MGy/fpy expected around the Target Assembly and HFTM/STUMM.
- Radiation Resistant Fiber Optic Strain Sensors: This type of strain gauges could be installed around the Target Assembly, HFTM and TC liner walls. This could be an interesting solution since recent studies at the SNS spallation target in ORNL show that they could survive up to 1000 MGy [45–47].
- Laser tracking by optical paths: Finally, other possible solution could be the use of shielded optical paths by mirrors across the TC liner and bunker to point towards specific fiducials placed on the Target Assembly, liner walls and HFTM. This diagnostic could be used during installation, commissioning and eventual position crosschecks during operation. Radiation resistance of such eventual solution as well as its contribution to neutron streamings outside the TC still need to be verified.

4. Conclusions

This work highlights the problematic of the Diagnostics of IFMIF-DONES, while describing strategies that are being proposed for managing their Requirements and Constraints. The work emphasizes the integration efforts that are necessary at the current project phase aiming at harmonizing the ongoing design of the different Systems. A transversal approach is considered a key aspect for a successful implementation, taking into account both Organizational Aspects and Technical Aspects. For the Organizational Aspects, a top-down strategy is being established, based on the use of common nomenclatures, a methodology for creating common Diagnostics and Instruments Databases, and standardization guidelines of components whenever possible. An important feature of this approach has been the definition and differentiation of *Instruments*, *Instrument Sets* and *Diagnostics*. These nomenclatures are used for the creation of a database that includes a hierarchical classification of Diagnostic Families and Instruments, aiming at improving the management of their requirements definition and the follow-up of solutions. A preliminary version of such top level classifications has been shown for the Accelerator Systems, Lithium Systems and Test Systems. Regarding the Technical Aspects, this work provided a general description of some of the most challenging and one-of-a-kind Diagnostics and Instruments within the Accelerator Systems, Lithium Systems and Test Systems. Common challenges involve functional requirements beyond the state-of-the-art of instruments as well as constraints associated to harsh operation environment (radiation, high temperatures, limited maintenance) and integration aspects (EMC, cable routing, space limitation). Extensive R&D programs are ongoing to find technical solutions that overcome these challenges, including execution of validation campaigns in close collaboration with other Facilities. Current and future works are focused on applying the proposed methodology extensively to all the IFMIF-DONES diagnostics and instruments for a systematic and transversal requirements definition and the pursuit of solutions to the Project.

Declaration of competing interest

The authors declare that they have no known competing financial interests or personal relationships that could have appeared to influence the work reported in this paper.

Data availability

Data will be made available on request.

Acknowledgements

This work has been carried out within the framework of the EUROfusion Consortium, funded by the European Union via the Euratom Research and Training Programme (Grant Agreement No 101052200 — EUROfusion). In addition, it has been financed by the Junta de Andalucía through the project “SE2021 UGR IFMIF-DONES” co-financed by the European Regional Development Fund ERDF “A way to make Europe”/“Andalusia moves with Europe”. Views and opinions expressed are however those of the author(s) only and do not necessarily reflect those of the European Union or the European Commission. Neither the European Union nor the European Commission can be held responsible for them. Funding for open access charge: Universidad de Granada/CBUA.

References

- [1] A. Ibarra, et al., The European approach to the fusion-like neutron source: the IFMIF-DONES project, *Nucl. Fusion* 59 (6) (2019) 065002, <http://dx.doi.org/10.1088/1741-4326/ab0d57>.
- [2] T. Donné, et al., *European Research Roadmap to the Realisation of Fusion Energy*, Tech. rep., EUROfusion, 2018.
- [3] D. Stork, R. Heidinger, T. Muroga, S. Zinkle, A. Moeslang, M. Porton, J.-L. Boutard, S. Gonzalez, A. Ibarra, Towards a programme of testing and qualification for structural and plasma-facing materials in 'fusion neutron' environments, *Nucl. Fusion* 57 (9) (2017) 092013, <http://dx.doi.org/10.1088/1741-4326/aa60af>.
- [4] A. Ibarra, F. Arbeiter, D. Bernardi, M. Cappelli, A. García, R. Heidinger, W. Krolas, U. Fischer, F. Martin-Fuertes, G. Micciché, A. Muñoz, F. Nitti, M. Pérez, T. Pinna, K. Tian, The IFMIF-DONES project: preliminary engineering design, *Nucl. Fusion* 58 (10) (2018) 105002, <http://dx.doi.org/10.1088/1741-4326/aad91f>.
- [5] W. Królas, A. Ibarra, F. Arbeiter, F. Arranz, D. Bernardi, M. Cappelli, J. Castellanos, T. Dézsi, H. Dzitko, P. Favuzza, A. García, J. Gutiérrez, M. Lewitowicz, A. Maj, F. Martin-Fuertes, G. Micciché, A. Muñoz, F. Nitti, T. Pinna, I. Podadera, J. Pons, Y. Qiu, R. Román, M. Toth, A. Zsakoi, The IFMIF-DONES fusion oriented neutron source: evolution of the design, *Nucl. Fusion* 61 (12) (2021) 125002, <http://dx.doi.org/10.1088/1741-4326/ac318f>.
- [6] I. Podadera, et al., The accelerator system of IFMIF-DONES multi-MW facility, in: 12th International Particle Accelerator Conference, 2021, pp. 1910–1913, <http://dx.doi.org/10.18429/JACoW-IPAC2021-TUPAB211>.
- [7] P. Arena, D. Bernardi, P.A. Di Maio, M. Frisoni, S. Gordeev, G. Micciché, F.S. Nitti, A. Ibarra, The design of the DONES lithium target system, *Fusion Eng. Des.* 146 (2019) 1135–1139, <http://dx.doi.org/10.1016/j.fusengdes.2019.02.024>, SI:SOFT-30.
- [8] T. Dézsi, F. Nitti, M. Tóth, S. Pásti, B. Balogh, A. Ibarra, Overview of the current status of IFMIF-DONES secondary heat removal system design, *Fusion Eng. Des.* 146 (2019) 430–432, <http://dx.doi.org/10.1016/j.fusengdes.2018.12.084>, SI:SOFT-30.
- [9] F. Martin-Fuertes, et al., Integration of safety in IFMIF-DONES design, *Safety* 5 (4) (2019) <http://dx.doi.org/10.3390/safety5040074>.
- [10] F. Schwab, et al., Thermomechanical analysis and design optimisations of the IFMIF-DONES HFTM, in: SOFT18, 2018.
- [11] T. Kuo, et al., Overview of the current status of IFMIF-DONES test cell biological shielding design, *Fusion Eng. Des.* 136 (2018) 628–632.
- [12] J. Barcena, et al., Design of the main building and plant systems of the IFMIF-DONES facility, in: SOFT18, 2018.
- [13] M. Cappelli, A. Bagnasco, J. Diaz, J. Sousa, F. Ambi, A. Campedrer, D. Liuzza, B. Carvalho, A. Ibarra, Status of the engineering design of the IFMIF-DONES central instrumentation and control systems, *Fusion Eng. Des.* 170 (2021) 112674, <http://dx.doi.org/10.1016/j.fusengdes.2021.112674>.
- [14] J. Knaster, F. Arbeiter, P. Cara, P. Favuzza, T. Furukawa, F. Groeschel, R. Heidinger, A. Ibarra, H. Matsumoto, A. Mosnier, H. Serizawa, M. Sugimoto, H. Suzuki, E. Wakai, IFMIF: overview of the validation activities, *Nucl. Fusion* 53 (11) (2013) 116001, <http://dx.doi.org/10.1088/0029-5515/53/11/116001>.
- [15] K. Atsushi, et al., Commissioning status of linear IFMIF prototype accelerator (LIPAC), in: 61st ICFA Advanced Beam Dynamics Workshop on High-Intensity and High-Brightness Hadron Beams, Daejeon, South Korea, 2018, p. THP1WB01, <http://dx.doi.org/10.18429/JACoW-HB2018-THP1WB01>.
- [16] H. Kondo, T. Kanemura, T. Furukawa, Y. Hirakawa, F. Groeschel, E. Wakai, The start-up and observation of the Li target in the EVEDA Li test loop, *Fusion Eng. Des.* 89 (7) (2014) 1688–1693, <http://dx.doi.org/10.1016/j.fusengdes.2014.02.022>, Proceedings of the 11th International Symposium on Fusion Nuclear Technology-11 (ISFNT-11) Barcelona, Spain, 15–20 September, 2013.
- [17] A. Aiello, A. Tincani, P. Favuzza, F. Nitti, L. Sansone, G. Micciché, M. Muzzarelli, G. Fasano, P. Agostini, Lifus (lithium for fusion) 6 loop design and construction, *Fusion Eng. Des.* 88 (6) (2013) 769–773, <http://dx.doi.org/10.1016/j.fusengdes.2013.02.129>, Proceedings of the 27th Symposium On Fusion Technology (SOFT-27); Liège, Belgium, September 24–28, 2012.
- [18] F. Arbeiter, et al., Design description and validation results for the IFMIF High Flux Test Module as outcome of the EVEDA phase, *Nucl. Mater. Energy* 9 (2016) 59–65, <http://dx.doi.org/10.1016/j.nme.2016.04.013>.
- [19] F. Arbeiter, et al., The accomplishments of lithium target and test facility validation activities in the IFMIF/EVEDA phase, *Nucl. Fusion* 58 (1) (2017) 015001, <http://dx.doi.org/10.1088/1741-4326/aa8ba5>.
- [20] U. Fischer, B. Bienkowska, K. Drozdowicz, M. Frisoni, F. Mota, F. Ogando, Y. Qiu, G. Stankunas, G. Tracz, Neutronics of the IFMIF-DONES irradiation facility, *Fusion Eng. Des.* 146 (2019) 1276–1281, <http://dx.doi.org/10.1016/j.fusengdes.2019.02.057>, SI:SOFT-30.
- [21] E. Bargallo, et al., Hardware availability calculations and results of the IFMIF accelerator facility, *Fusion Eng. Des.* 89 (9) (2014) 2388–2392, <http://dx.doi.org/10.1016/j.fusengdes.2014.01.030>, Proceedings of the 11th International Symposium on Fusion Nuclear Technology-11 (ISFNT-11) Barcelona, Spain, 15–20 September, 2013.
- [22] J. Marroncle, et al., IFMIF-LIPAC diagnostics and its challenges, in: Proceedings of IBIC2012, 2013, p. WECC01.
- [23] I. Podadera, B. Brañas, P. Cara, A. Guirao, A. Ibarra, D. Jiménez-Rey, E. Molina Marinas, J. Mollá, C. Oliver, R. Varela, Beam diagnostics for the Multi-MW hadron linac IFMIF/DONES, in: 5th International Beam Instrumentation Conference, 2017, p. MOPG32, <http://dx.doi.org/10.18429/JACoW-IBIC2016-MOPG32>.
- [24] B. Bolzon, et al., Beam diagnostics of an ECR ion source on LIPAc injector for prototype IFMIF beam accelerator, *Fusion Eng. Des.* 136 (2018) 1300–1305, <http://dx.doi.org/10.1016/j.fusengdes.2018.04.128>, Special Issue: Proceedings of the 13th International Symposium on Fusion Nuclear Technology (ISFNT-13).
- [25] D. Sánchez-Herranz, O. Nomen, F. Arranz, S. Coloma, I. Podadera, R. Varela, Design of the HEBT components inside TIR room of the IFMIF DONES facility, *Fusion Eng. Des.* 168 (2021) 112636, <http://dx.doi.org/10.1016/j.fusengdes.2021.112636>.
- [26] Y. Giomataris, et al., MICROMEGAS: a high-granularity position-sensitive gaseous detector for high particle-flux environments, *Nucl. Instrum. Methods Phys. Res. A* 376 (1) (1996) 29–35, [http://dx.doi.org/10.1016/0168-9002\(96\)00175-1](http://dx.doi.org/10.1016/0168-9002(96)00175-1).
- [27] D. Kittelmann, et al., Neutron sensitive beam loss monitoring system for the European Spallation Source linac, *Phys. Rev. Accel. Beams* 25 (2022) 022802, <http://dx.doi.org/10.1103/PhysRevAccelBeams.25.022802>.
- [28] P. Cara, et al., The linear IFMIF prototype accelerator (LIPAC) design development under the European-Japanese collaboration, in: Proc. of International Particle Accelerator Conference (IPAC'16), Busan, Korea, May 8–13, 2016, in: International Particle Accelerator Conference, no. 7, JACoW, Geneva, Switzerland, 2016, pp. 985–988, <http://dx.doi.org/10.18429/JACoW-IPAC2016-MOPOY057>.
- [29] K. Kondo, et al., Validation of the linear IFMIF prototype accelerator (LIPAC) in rokasho, *Fusion Eng. Des.* 153 (2020) 111503, <http://dx.doi.org/10.1016/j.fusengdes.2020.111503>.
- [30] C. Neri, L. Bartolini, A. Coletti, M. Ferri de Collibus, G. Fornetti, F. Pollastrone, M. Riva, L. Semeraro, The laser in vessel viewing system (IVVS) for iter: Test results on first wall and divertor samples and new developments, *Fusion Eng. Des.* 82 (15) (2007) 2021–2028, <http://dx.doi.org/10.1016/j.fusengdes.2006.12.006>, Proceedings of the 24th Symposium on Fusion Technology.
- [31] B. Brenneis, S. Gordeev, S. Ruck, L. Stoppel, W. Hering, Wake shape and height profile measurements in a concave open channel flow regarding the target in DONES, *Energies* 14 (20) (2021) <http://dx.doi.org/10.3390/en14206506>.
- [32] D. Winder, Evolution of the high-power spallation neutron mercury target at the SNS, in: Proc. IPAC'21, in: International Particle Accelerator Conference, no. 12, JACoW Publishing, Geneva, Switzerland, 2021, pp. 3735–3739, <https://jacow.org/ipac2021/papers/thxc03.pdf>.
- [33] Y. Kato, H. Katsuta, S. Konishi, M. Ogoshi, T. Hua, L. Green, S. Cevolani, Impurity control in liquid lithium loop for IFMIF target facility, *J. Nucl. Mater.* 258–263 (1998) 394–399, [http://dx.doi.org/10.1016/S0022-3115\(98\)00405-X](http://dx.doi.org/10.1016/S0022-3115(98)00405-X).
- [34] G.K. Creffield, M.G. Down, R.J. Pulham, Electrical resistivity of liquid and solid lithium, *J. Chem. Soc. Dalton Trans.* (1974) 2325–2329, <http://dx.doi.org/10.1039/DT9740002325>.
- [35] N. Holstein, W. Krauss, J. Konys, F.S. Nitti, Development of an electrochemical sensor for hydrogen detection in liquid lithium for IFMIF-DONES, *Fusion Eng. Des.* 146 (2019) 1441–1445, <http://dx.doi.org/10.1016/j.fusengdes.2019.02.100>, SI:SOFT-30.
- [36] R. Ortwein, J. Kotula, U. Wiacek, J. Swierblewski, D. Bocian, Hydraulic analysis of the start-up monitoring module (STUMM) for IFMIF-DONES, *Fusion Eng. Des.* 171 (2021) 112601, <http://dx.doi.org/10.1016/j.fusengdes.2021.112601>.
- [37] F. Arbeiter, A. Abou-Sena, Y. Chen, B. Dolensky, T. Heupel, C. Klein, N. Scheel, G. Schlindwein, Development and validation status of the IFMIF High Flux Test Module, *Fusion Eng. Des.* 86 (6) (2011) 607–610, <http://dx.doi.org/10.1016/j.fusengdes.2011.01.031>, Proceedings of the 26th Symposium of Fusion Technology (SOFT-26).
- [38] C. Klein, F. Arbeiter, T. Martin, P. Taubmann, Hydraulic and thermal testing of different helium cooled irradiation rig models for the IFMIF High Flux Test Module, *Fusion Eng. Des.* 104 (2016) 71–75, <http://dx.doi.org/10.1016/j.fusengdes.2015.12.058>.
- [39] Y. Qiu, F. Arbeiter, U. Fischer, F. Schwab, IFMIF-DONES HFTM neutronics modeling and nuclear response analyses, *Nucl. Mater. Energy* 15 (2018) 185–189, <http://dx.doi.org/10.1016/j.nme.2018.04.009>.
- [40] S. Fiore, Characterization of self powered neutron detectors in the nTOF target pit and outlook for the future, in: nTOF Collaboration Meeting, November 27–28 Granada (Spain), 2018.
- [41] D. Rapisarda, et al., Feasibility of fission chambers as a neutron diagnostic in the IFMIF—Test cell, *Fusion Eng. Des.* 84 (7) (2009) 1570–1574, <http://dx.doi.org/10.1016/j.fusengdes.2009.02.004>, Proceeding of the 25th Symposium on Fusion Technology.
- [42] D. Rapisarda, et al., Study on the response of IFMIF fission chambers to mixed neutron-gamma fields: PH-2 experimental tests, *Fusion Eng. Des.* 86 (6) (2011) 1232–1235, <http://dx.doi.org/10.1016/j.fusengdes.2011.03.079>, Proceedings of the 26th Symposium of Fusion Technology (SOFT-26).
- [43] A. Klíx, F. Arbeiter, M. Majerle, Y. Qiu, M. Štefánik, Measurement of neutron fluence in the High-Flux Test Module of the Early Neutron Source by neutron activation, *Fusion Eng. Des.* 146 (2019) 1258–1261, <http://dx.doi.org/10.1016/j.fusengdes.2019.02.053>, SI:SOFT-30.

- [44] A. Masi, S. Danzeca, R. Losito, P. Peronnard, R. Secondo, G. Spiezia, A high precision radiation-tolerant LVDT conditioning module, *Nucl. Instrum. Methods Phys. Res. A* 745 (2014) 73–81, <http://dx.doi.org/10.1016/j.nima.2014.01.054>.
- [45] Y. Liu, W. Blokland, J. Bryan, A. Rakhman, B. Riemer, R. Sangrey, R. Strum, M. Wendel, D. Winder, Radiation-resistant fiber optic strain sensors for SNS target instrumentation, in: 7th International Particle Accelerator Conference, 2016, p. MOPMR055, <http://dx.doi.org/10.18429/JACoW-IPAC2016-MOPMR055>.
- [46] W. Blokland, et al., Strain and temperature measurements from the SNS mercury target vessel during high intensity beam pulses, in: 8th International Particle Accelerator Conference, 2017, <http://dx.doi.org/10.18429/JACoW-IPAC2017-TUOBA3>.
- [47] Y. Liu, W. Blokland, C. Long, S. Murray, B. Riemer, R. Sangrey, M. Wendel, D. Winder, Strain measurement in the recent SNS mercury target with gas injection, *J. Phys. Conf. Ser.* 1067 (2018) 052022, <http://dx.doi.org/10.1088/1742-6596/1067/5/052022>.